

FIFA Quality Programme for Footballs (outdoor, futsal and beach soccer footballs)

Testing Manual

May 2015

FIFA[®]

For the Game. For the World.

Contents

1 – The FIFA Quality Programme for Footballs	3
1.1 General information.....	3
1.2 The FIFA Quality Programme for Footballs – Licensing	3
2 – Test protocol	4
2.1 Samples and sample preparation	4
2.1.1 Football samples	4
2.1.2 Sample preparation.....	4
2.2 Testing order	5
2.2.1 FIFA QUALITY PRO & FIFA QUALITY	5
2.2.2 INTERNATIONAL MATCH STANDARD (IMS).....	5
3 – Test Methods and Equipment.....	6
3.1 Circumference – FIFA Footballs Test 01	6
3.2 Sphericity – FIFA Footballs Test 02	7
3.3 Rebound – FIFA Footballs Test 03	8
3.4 Water absorption – FIFA Footballs Test 04.....	11
3.5 Weight – FIFA Footballs Test 05	12
3.6 Loss of pressure – FIFA Footballs Test 06.....	12
3.7 Shape and size retention – FIFA Footballs Test 07	13
3.8 Balance – FIFA Footballs Test 08	14
3.9 Material analysis – FIFA Footballs Test 09	16
4 – Test requirements.....	17
4.1 Outdoor footballs	17
4.2 Futsal.....	18
4.3 Beach soccer.....	19

While every effort has been made to ensure the accuracy of the information contained in this testing manual, any party who makes use of any part of this manual in the development of Footballs (a “User”) does so at its own risk and FIFA shall have no liability with regard to such use. Any use of this manual including by undergoing any test of a system by a User constitutes acceptance of the terms of this disclaimer by that User. This testing manual and the test procedures therein are FIFA’s intellectual property. FIFA reserves the right to amend, update or delete sections of this manual at any time as it deems fit.

1 – The FIFA Quality Programme for Footballs

1.1 General information

In March 1995 the International Football Association Board decided to adopt compulsory testing and marking for footballs to be used in official matches. Official matches are all competitions (both indoor and outdoor) played under the authority of FIFA or the confederations and recognised by FIFA.

Law 2 of the Laws of the Game for Outdoor Football, Futsal and Beach Soccer require that footballs eligible for FIFA and confederation matches meet minimum quality standards. Such footballs have to be tested, certified and marked with one of the FIFA quality marks or the reference “International Match Standard” [IMS]. Law 2 of the Futsal Laws of the Game further states that no felt balls are permitted for FIFA and confederation matches.

The testing and certification for the FIFA Quality Programme under which footballs that meet the minimum standards may bear the FIFA quality marks is executed by EMPA (Swiss Federal Laboratories for Materials Science and Technology), a leading, independent test institute. Testing and certification for the International Matchball Standard is carried out by other independent test institutes selected by FIFA.

This technical guide contains an overview of the quality criteria behind the three marks FIFA QUALITY PRO, FIFA QUALITY and INTERNATIONAL MATCH STANDARD.



1.2 The FIFA Quality Programme for Footballs – Licensing

In response to the need for better-quality products in top-level matches and the constant developments in sports equipment, stringent quality requirements for Outdoor, Futsal and Beach Soccer have been developed. In order to offer more visibility and exposure, FIFA created a licensing programme which, subject to an agreement being signed with FIFA, allows manufacturers to display the marks on the tested ball models. To this effect, the two quality levels FIFA QUALITY PRO, the professional standard recommended for all top level matches and FIFA QUALITY, the general level for training and broader use can be displayed on a ball that was successfully tested thus displaying to the public that it meets the requirements. The third quality level, IMS may be used irrespective of any licensing scheme subject only to successful testing by the accredited test institutes.

Licensees benefit from the worldwide protection and enforcement of the FIFA quality marks as well as from a marketing service package which includes advertising and PR campaigns, various promotional opportunities and protection of their licensing rights.

For any questions relating to the FIFA Quality Programme for Footballs please contact Quality@FIFA.org

2 – Test protocol

2.1 Samples and sample preparation

Specific test methods have been developed for testing footballs on the minimum requirements for the categories FIFA QUALITY PRO and FIFA QUALITY and IMS of the FIFA Quality Programme. Below an overview of the required samples is given.

2.1.1 Football samples

Identical samples of the model to be tested shall be sent to the test institute. Depending on the test to be performed, the following number is required:

FIFA QUALITY PRO	10 samples
FIFA QUALITY	10 samples
IMS	7 samples

Upon receipt of the samples the test institute shall allocate a number to each of the samples between 1 and 10 (or 1 and 7 for IMS). This number will determine the tests which the ball is to be used for.

2.1.2 Sample preparation

Unless explicitly stated in the testing procedure within this manual, the following conditions shall be used for all of the tests.

Test conditions

The ambient conditions during testing shall be a room temperature of $20^{\circ}\text{C} \pm 2^{\circ}\text{C}$ and a humidity of $65\% \pm 5\%$

Inflating (Ball pressure)

The footballs are inflated with compressed air to a defined pressure. The air pressure in the football is measured with a pressure gauge; A valve for the release of air is situated between the pressure gauge and the needle. The needle is to be lubricated with glycerin.

A pressure gauge 1.5 bar with an accuracy of ± 0.01 bar is to be used for inflating. The pressure gauge shall be calibrated each year by a certified lab.

The following nominal values for ball pressure are to be applied:

- Outdoor	$0.8\text{bar} \pm 0.01$
- Futsal	$0.6\text{bar} \pm 0.01$
- Beach Soccer*	$0.6\text{bar} \pm 0.01$

* mean value of the indicated 0.375 – 0.8bar.



Conditioning

The footballs are conditioned for at least 24 hours in a standard atmosphere of temperature $20^{\circ}\text{C} \pm 2^{\circ}\text{C}$ and relative humidity $65\% \pm 5\%$.

2.2 Testing order

The tests are to be carried out in the order indicated below. Unless noted in the individual test procedure, all the ball samples allocated to a specific test shall be tested.

2.2.1 FIFA QUALITY PRO & FIFA QUALITY

 & 	Sample number	Testing order	Outdoor	Futsal	Beach Soccer
	1, 2, 3	1. Circumference 2. Sphericity 3. Shape / size retention 4. Water absorption (5.) Balance	X X X X -	X X X -	X X X - X
4, 5, 6	1. Weight 2. Loss of pressure	X X	X X	X X	X X
7, 8, 9	1. Rebound 2. Balance	X -	X -	X X	X -
6	Kept as reference sample	X	X	X	X
10	Material analysis	X	X	X	X

2.2.2 INTERNATIONAL MATCH STANDARD (IMS)

	Sample number	Testing order	Outdoor	Futsal	Beach Soccer
	1, 2, 3	1. Circumference 2. Sphericity 3. Rebound 4. Water absorption (5.) Balance	X X X X -	X X X X -	X X X - X
4, 5, 6	1. Weight 2. Loss of pressure	X X	X X	X X	X X
7	Kept as reference sample	X	X	X	X

3 – Test Methods and Equipment

3.1 Circumference – FIFA Footballs Test 01

Principle

The circumference test indicates the dimension of the ball as an average value based on different axes of measurement. This test is critical to ensure the ball is the correct size for the game of football.

Apparatus

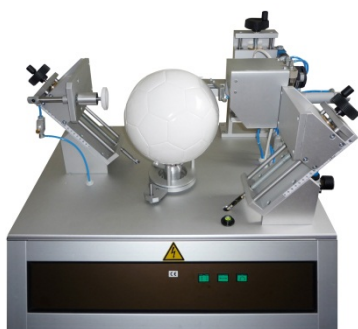

The circumference is determined by the CSM* (Circumference and Sphericity Measuring System) ball test machine in combination with an ordinary PC and the related CSM- software package. The implemented “FIFA mode” runs an optimised test procedure and delivers the final results for the FIFA QUALITY PRO and FIFA QUALITY and IMS categories. The CSM manual shows in detail the handling, calibration and measurements of the whole test system.

* The CSM machine is built by SAJ Electronic, Dahner Strasse 9, DE-76846 Hauenstein Germany. For further information please contact quality@fifa.com.

Procedure

Start the CSM machine in accordance with its manual. Check the pressure of the ball then place the ball on the retainer inside the machine paying attention to the following:

- The valve is on the upside and centred. An arrow is drawn on the panel with the valve and it turned to point to the right side (view from in front of machine).
- Grippers and tangential arms are adjusted to the centre line of the ball

Start the measurement in accordance with the FIFA mode and note the obtained value (.sph) that are transcribed into the measuring reports (rtf or .pdf)

Calculation and expression of results

The CSM machine running off the software in “FIFA mode” will provide results based on the following measurements:

- Radius measurement (r_m = mean value of 3 sequences with 15 cycles)
- 4,500 points measured all over the ball (3 x 15 x 100 radius values)
- Circumference calculation: $2 \times r_m \times \pi$

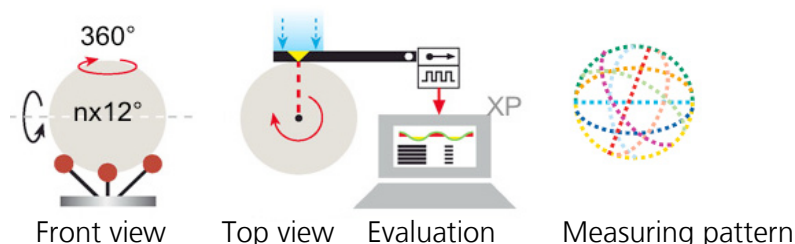

The radius is measured by the CSM machine in FIFA Mode. The circumference is calculated automatically as an average of 3 radii (calculated of 15 cycles each is used) $\times 2 \times \pi$, according to the FIFA definition avg. of 3 radii (45 cycles, split 3x15).

3.2 Sphericity – FIFA Footballs Test 02

Principle

The sphericity test analyses how round the football is by means of an average of several measurements of the ball's radius.

Apparatus



The circumference is determined by the CSM* ball test machine in combination with an ordinary PC and the related CSM- software package. The implemented "FIFA mode" runs an optimised test procedure and delivers the final results for the FIFA QUALITY PRO and FIFA QUALITY and IMS categories. The CSM manual shows in detail the handling, calibration and measurements of the whole test system.

* The CSM machine is built by SAJ Electronic, Dahner Strasse 9, DE-76846 Hauenstein Germany. For further information please contact quality@fifa.com.

Procedure

Start the CSM machine in accordance with its manual. Check the pressure of the ball then place the ball on the retainer inside the machine paying attention to the following:

- The valve is on the upside and centred. An arrow is drawn on the panel with the valve and it turned to point to the right side (view from in front of machine).
- Grippers and tangential arms are adjusted to the centre line of the ball

Start the measurement in accordance with the FIFA mode and note the obtained value (.sph) that are transcribed into the measuring reports (rtf or .pdf)

Calculation and expression of results

The CSM machine running off the software in "FIFA mode" will provide results based on the following measurements:

- Radius measurement (r_m = mean value of 3 sequences with 15 cycles)
- 4,500 points measured all over the ball (3 x 15 x 100 radius values)
- Sphericity calculation:
 - Mean value of the $r_{dev\ max}$ of the 3 sequences [%]
 - $r_{dev\ max}$ = max. absolute difference of $r_x - r_m$ [%]

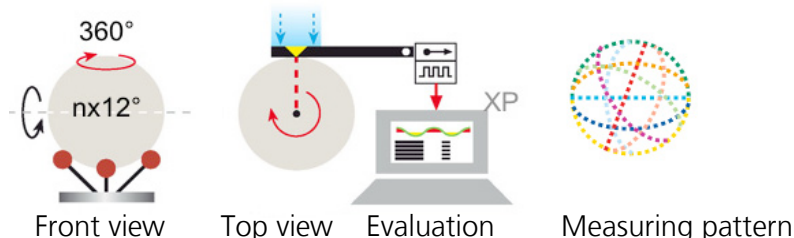

Calibration of CSM device

The device has to be calibrated on a monthly basis according to the manual (verification using a metal disc of known diameter which will have to be checked all five years)

3.3 Rebound – FIFA Footballs Test 03

Principle

The sample ball is dropped in a guided free fall with a defined velocity on to a fixed plate (see test conditions below, anvil material and mass). The ball hits the surface at specific points in the middle of the panels, distributed over the surface of the ball. The panels will be selected such that the number of testing points are evenly distributed on the different panel shapes.

Using a video camera, the height of rebound, from the underside side of the ball, can be determined. Alternatively also acoustic measurement is possible.

After the first rebound, the camera is moved to approximately the same height, and the height above anvil is noted. Any parallax error caused by the difference between the height of rebound and the camera height is corrected mathematically during the evaluation of the results.

Apparatus

The apparatus to be used must allow for the ball to free fall vertically from a height of $2.00\text{m} \pm 0.01\text{m}$ (measured from the bottom of the ball without imparting any impulse of spin. The surface that the ball is to rebound on shall be metal for outdoor and beach soccer balls (rigidly connected to a solid underground of at least 1000kg) and 40 mm thick beech wood (3 plies crosswise glued and rigidly connected to the anvil) above a steel anvil for futsal balls.

Different guidance and measurement systems may be used:

1. Video-based measurement
 - Guidance system with a ring for placing the ball on the anvil
 - Plane anvil (material see below) attached to a plate of metal and a base of concrete
 - Measuring device for the determination of the velocity at the impact of the ball
 - Fixed scale for the determination of the height of rebound (to the nearest 1cm)
 - Video camera (digital recording system)
2. Acoustic measurement
 - An electro-magnetic or vacuum release mechanism
 - Vertical scale to allow the drop height of the ball to be established.
 - Timing device, activated acoustically, capable of measuring to an accuracy of 1ms.

Test conditions (see procedure 2 overleaf for special conditions for “cold tests”)

- | | |
|---------------------------|---|
| • Ball sample preparation | Conditioning and pressure see point 2.1.2 |
| • Velocity at the impact | $6.25 \pm 0.15/\text{sec}$ (equals a drop height of 2m) |
| • Number of samples | 3 |
| • Test climate | as described in 2.1.2 |
| • Measurements per sample | 10 (ambient conditions) and 3 (cold temperature) |

Procedure

1. Test with ball at ambient temperature:

The ball is placed at the 2.00m±0.01m position and is released mechanically. The height is recorded. The procedure is repeated 10 times per football ensuring no two rebounds hit the same spot on the ball. Distribution of measurement points according to panel shape. Rebound on center of panel.

2. Test with ball at cold temperature (to be performed in addition for outdoor footballs only):

The test procedure is repeated 5 times with footballs that were exposed to cold.

The samples are inflated to 0.9bar and stored for 11 hours (±30 min) at 5°C. The samples are then removed from the cooler, the pressure is adjusted to 0.82bar and they are replaced into storage at 5°C for another 1 hour (+15 min). Directly prior to testing, the pressure is adjusted to 0.80bar.

The tests are still performed at ambient room temperature. The time between the removal of the ball from the storage at 5°C and the beginning of the test shall not exceed 2 minutes. If the test is not completed within 2 minutes, the procedure must be restarted.

The ball is placed at the 2.00m±0.01m position and is released mechanically. The height is recorded. The procedure is repeated 5 times per football ensuring no two rebounds hit the same spot on the ball (whereby the first and fifth rebound are to be discarded from the calculation of the average).

Calculation and expression of results

The ball rebound height of any tested sample is the mean of the 10 values (outdoor, beach soccer) respectively 3 values (futsal) from the 10 rebounds (outdoor, beach soccer) or 3 rebounds (futsal) performed from each ball in ambient conditions. The mean value of each of the three samples must fall within the requirements. In addition, the difference between the highest and lowest means shall be compared and shall also fall within the respective requirement.

1. Video-based measurement:

Record the height of the ball rebound by reading the height off the fixed ruler on the video camera footage.

2. Acoustic measurement

For each test calculate the rebound height using the formula: $H = 1.23 (T - \Delta t)^2 \times 100$

Where:

H = rebound height in cm

T = the time between the first and second impact in seconds

$\Delta t = 0.025s$

Report the value of ball rebound to the nearest 0.01m as an absolute value in metres e.g. 1.36m.

Note on velocity of falling footballs

Theoretical velocity after a free fall from 2m height $v_{\text{theor}} = 6.264\text{m/s}$

Measured velocity of the guidance system $v = 6.19 \pm 0.01\text{m/s}$

The velocities measured in this case are between 98.6% and 99.0% of the velocity at free fall. This reduction is due to the friction of the guidance system (see enclosure).

It has not been observed that the football loses contact with the guidance system during the fall. Calculations indicate that from 2m drop height, the velocity of the football can be reduced by air resistance

to 98.0 – 99.5% of the theoretical velocity at free fall (see enclosure). The effect of the friction of the guidance system is comparable with the effect of the air resistance of the ball.

Velocity of Falling Footballs

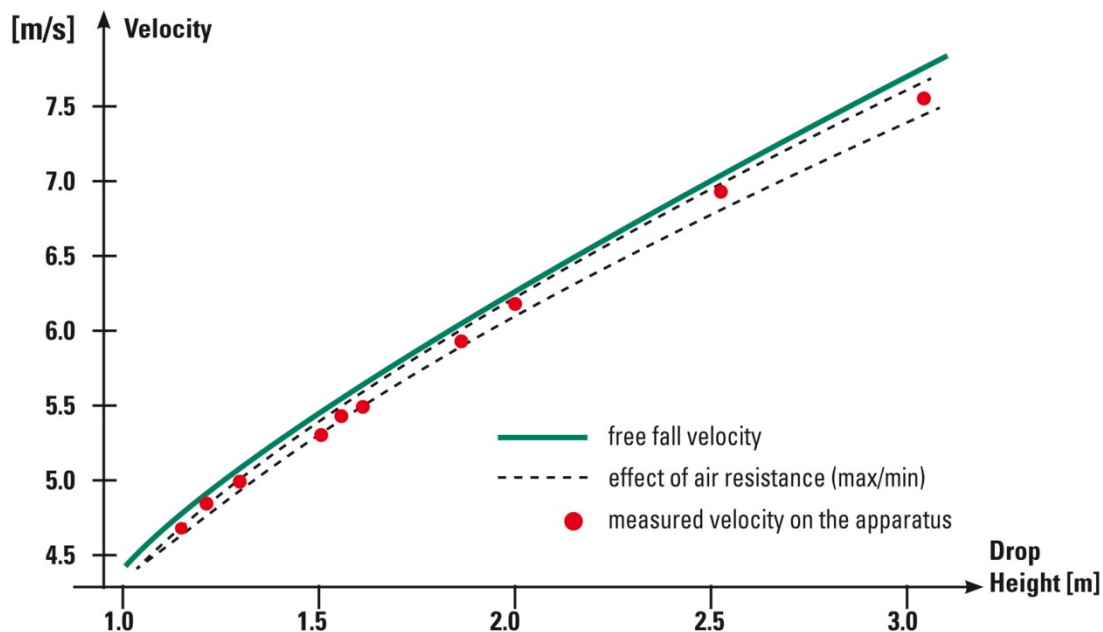

- Free fall velocity 6.26m/s
- Velocity with minimum air resistance (c = 0.1) 6.23m/s
- Measured velocity of the guidance system 6.19 +/- 0.01m/s
- Velocity with maximum air resistance (c = 0.4) 6.13m/s

3.4 Water absorption – FIFA Footballs Test 04

Principle

The football is placed in a receptacle filled with water. The ball is then compressed into the water by means of a pneumatic piston and left to soak in the water. The ball is then weighed again after 250 compression cycles and compared to the original weight.

Apparatus

The apparatus contains a variable pneumatic piston, which is capable of compressing to various depths. A system of three additional small pneumatic pistons turns the football in various directions between the compressions (one complete turn in approx. 20 compressions). Thus, the complete football comes in contact with the water during the test.

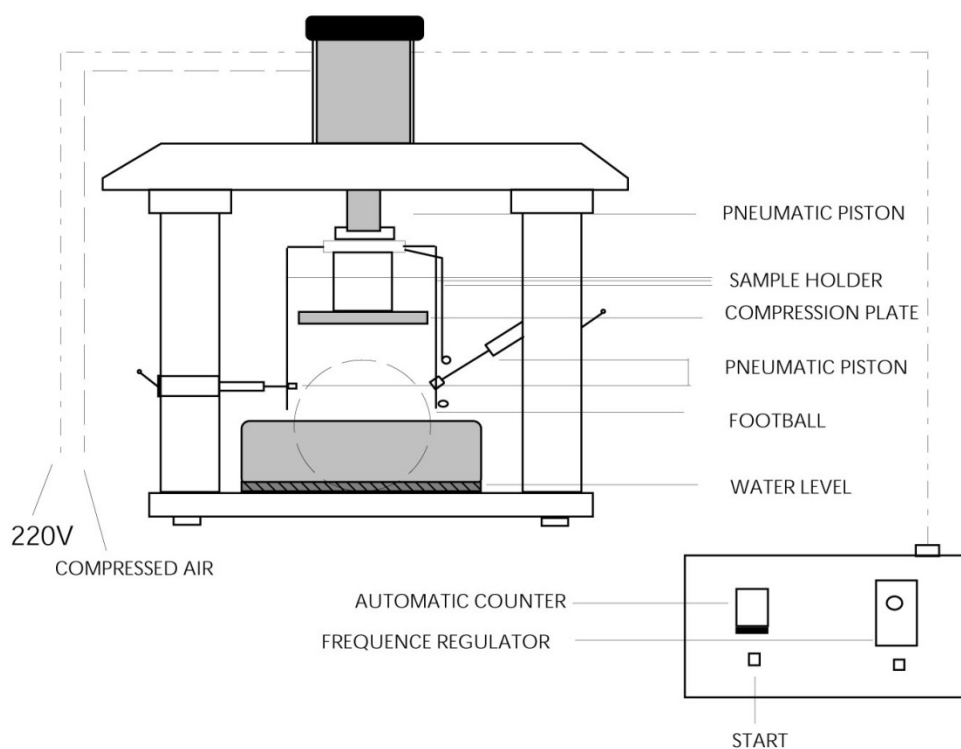

The machine must be capable of achieving a compression of 25% of any tested football’s diameter. The piston shall be capable of a frequency of at least 40 compressions per minute.

The receptacle shall be round and with a diameter of 30 cm ±2. It shall be filled with 2cm ±0.2 of water. If a pressure plate is used for achieving compression, the diameter shall be 16cm ±1.

Note: “Water absorption” is expressed as a percentage of the initial weight of the sample.

Regular calibration (and least annually) to ensure cycle time, compression and ball coverage is necessary.

Procedure

Each of the samples is conditioned and weighed using electronic scales as defined in FIFA Footballs Test 05. The amplitude of compression is calculated from the mean diameter obtained from the circumference test (FIFA Footballs Test 01).

A compression equal to 25% of the diameter (10% for beach soccer) of the ball is applied at 40 compressions per minute. The compression can be measured by means of a compression plate of the distance between the plate and the piston.

After 250 compressions the ball shall be removed quickly and wiped dry on the surface using a standard towel. Each ball is then weighed again in the same manner as above.

Note: Amount of compression (end position of piston) will have to be adjusted for each type of ball (according to diameter determined under 3.1)

Calculation and expression of results

A value is indicated for each of the tested samples reflecting the percentage increase in weight after the water absorption test using the weight before the water absorption test as benchmark. The results are rounded to one decimal. Each single value must fall within the requirements.

3.5 Weight – FIFA Footballs Test 05

Principle

In addition to the standard ball sample preparation and ambient temperature, this test should be done in a wind protected area to avoid any external influence.

Apparatus

Electronic scales with an accuracy of 0.01g are to be used for this test. Annual calibration is required for this device.

Procedure

The pre-conditioned football is placed on the scales. Once it has been ensured that there are no wind effect, record the weight. Repeat the procedure. Should the subsequent value vary by more than $\pm 0.02g$, discard the results and repeat the test. Five measurements shall be made per sample for outdoor, beach soccer and futsal balls.

The same procedure is to be followed for all three samples used during this test.

Calculation and expression of results

The average value from the 5 measurements is noted for each of the samples individually.

3.6 Loss of pressure – FIFA Footballs Test 06

Principle

This test measures the difference in pressure over time. The aim is to ensure that the ball does not deflate too quickly.

Apparatus

A pressure gauge as defined in section 2.1.2 of this manual shall be used for these tests.

Procedure

Following the weight test, the samples are adjusted to ensure air pressure is at least as per 2.1.2 of this manual. The samples are then stored for 72h. The pressure is then measured again.

Calculation and expression of results

For each of the samples, the loss of pressure is to be expressed as a percentage loss between the second measurement and the initial measurement of pressure. The value for each of the three samples shall be reported.

3.7 Shape and size retention – FIFA Footballs Test 07

Principle

The ball is repeatedly shot by a canon against a metal surface before automatically being returned into the canon. The number of cycles simulates use over a period of time. The worn samples can then be re-checked for size, weight and shape in order to ensure they do not change significantly with use.

Apparatus – Construction of the “Shooting device for footballs”

The apparatus used for this test fulfils the criteria below.

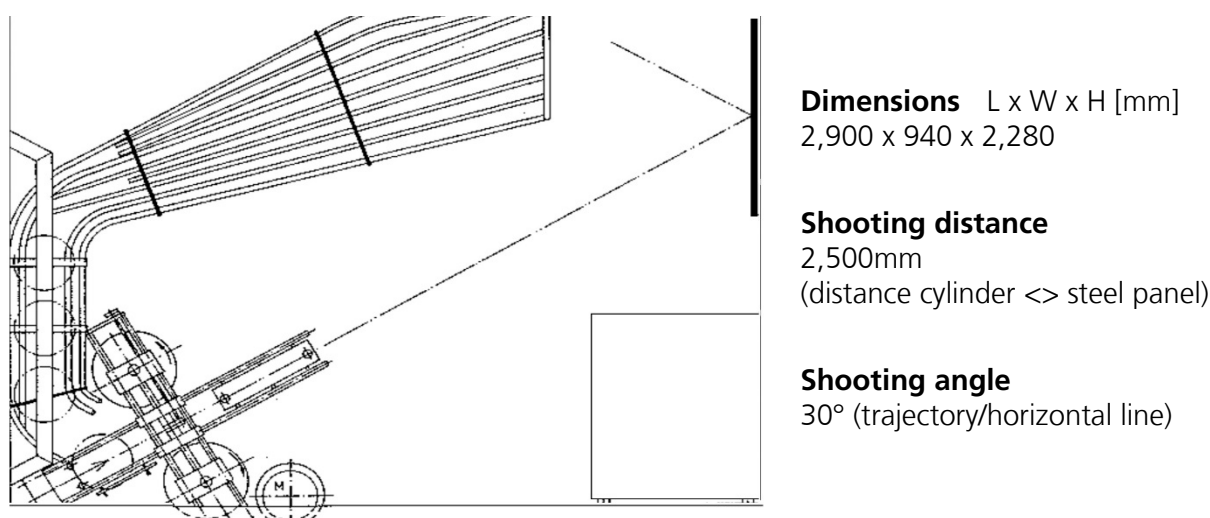

Ball insertion	Distance of insertion	max. 320mm
	Force used of insertion	max. 800N
Power	Electric motor	Type 112-M 380/660V
	Number of revolution	max. 1420rpm
	Transmission ratio	0.6
Cylinders	Circumference	1000mm
	Diameter	318.3mm
	Material	steel, hard chromium plated
	Surface roughness	1 - 2µm
	Changeable range	120 - 250mm
	Number of revolutions	max. 852rpm
	Velocity	max. 51.1km/h*
Steel panel	Dimension	800 x 800mm

Material	stainless steel
Surface roughness	1 - 2µm

* The velocity is calculated from the time taken for the first 0.4m of the ball's trajectory using two photoelectrical barriers coupled to an electronic calculator and display. The velocity is controlled by adjusting the rpm of the motor.

Procedure

The footballs are conditioned as per the general guidelines and are placed in the shooting machine. Each of the three samples is shot with an exit speed of 50km/h \pm 1 against the steel plate at an angle of 30° \pm 2 based on the horizontal line. The samples are shot 2000 times for outdoor and futsal balls and 1000 times for beach soccer balls.

Following shooter test the ball is placed in ambient laboratory conditions (20 \pm 2°C and 65 \pm 5 % R.H) for a minimum of one hour. Afterwards pressure measurement is made at, laboratory conditions (20 \pm 2°C and 65 \pm 5 % R.H). The following tests are carried out (in the stated order) with all three ball samples:

1. Pressure of the samples after shooting
2. Visual inspection of seams and air valve
3. Circumference (FIFA Footballs Test 01)
4. Sphericity (FIFA Footballs Test 02)

Calculation and expression of results

The results from the tests performed after the 2000 cycles (1000 for beach soccer) are noted as follows:

1. Initial pressure of the samples (before shooting) minus pressure after shooting gives pressure loss expressed in bar with 2 decimal places; example -0.02 bar.
2. Visual inspection: evidence of any damage (to be documented photographically)
3. Circumference (FIFA Footballs Test 01): results as per test method
4. Sphericity (FIFA Footballs Test 02): results as per test method

The values of circumference, sphericity and pressure are compared to the values from the previous tests according to FIFA Footballs Test 01, 02 and 06. The difference between the value obtained after the shooter test and prior to it is denoted as an absolute increase for circumference and pressure and a percentage for sphericity.

3.8 Balance – FIFA Footballs Test 08

Principle

The balance test is exclusively for Futsal balls and measures how straight the ball rolls along a flat surface. The conditioned ball samples are rolled down a defined inclined surface, which guides the ball on to a table. The angle at which the ball rolls over the table is measured. The mean is taken.

Apparatus

A slope consisting of an inclined plane at 5° and with a length of 1500mm \pm 15mm is joined to a flat surface with a length of 1500mm \pm 15mm. Two guide bars are attached to the slope so that the angle

of a plane at 90° from the centre of the two bars is 160° (see diagramme below). The surface of the flat plane shall be a wool felt in accordance with EN ISO 12947-1.

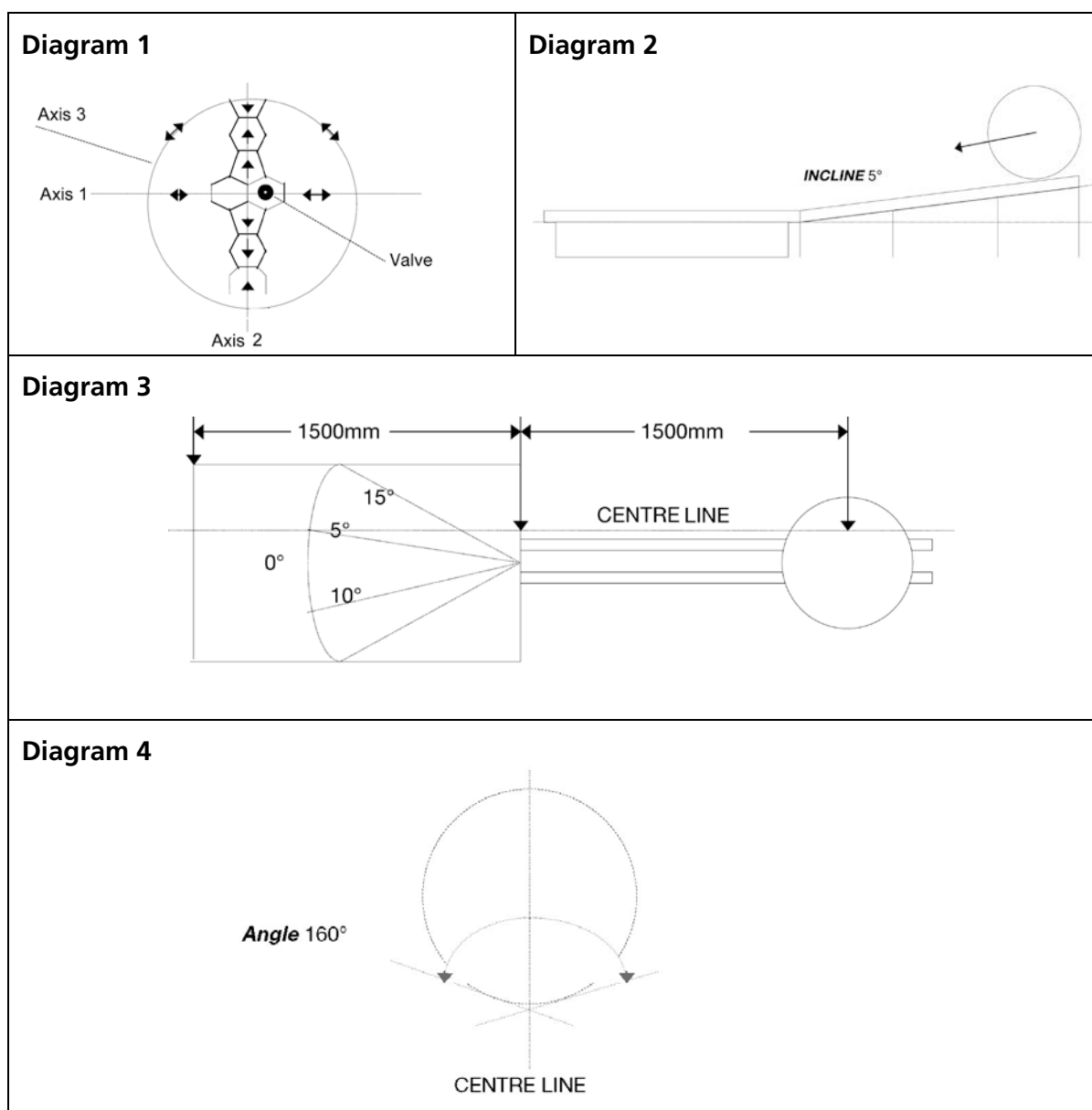

Procedure

Three axes, at right angles to each other, are marked on the ball. One axis goes through the panel with the valve. Each axis is chosen so that it runs through the middle of the eight panels (see diagram 1). The panels of each axis are numbered 1 to 8.

Panel 1 is placed on the guide bars 1500mm from the edge of the table. This axis (which goes through panel one) must be in line with the (imaginary) centre line of the apparatus (see diagrams 3/4). The ball is placed on the slope so that the ball rolls from panels 1 to 2, 2 to 3 and so on. No additional spin should be added to the ball. The ball must roll smoothly down the guide bars so that the ball continues to roll over the same axis as at the start i.e. no bobbling. As the ball rolls off the ramp on to the table surface the transition should be smooth with no bobbling or abrupt changes in direction taking place.

The angle at which the ball deviates from the central axis is recorded (see diagram 3).

The test is repeated starting on panel 2 etc. of this axis. Panels 1, 2, 5 and 6 are tested in one direction, with panels 3, 4, 7 and 8 tested in the opposite direction.

The same procedure is repeated for the other two axes.

Calculation and expression of results

The results from the 24 measurements are calculated into an average value which is noted for the sample.

3.9 Material analysis – FIFA Footballs Test 09

Principle

The materials test is used to identify the composition of the product. It does not constitute a pass/fail criterion. It allows the identification of any model from a specific series which is then compared to the manufacturer's declaration of this ball and can be used during spot checks to ensure the model corresponds to the tested samples and the declared composition.

Apparatus

This test requires a sharp cutting device (for example a box cutter) and a microscope for the analysis of the sample.

Requirements for microscope:

- magnification at least 50..200x
- Resolution of camera: min. 5MP

Procedure

The material is cut out of the middle of two neutral panels (no valve) at $90^\circ \pm 2^\circ\text{C}$ with clear edges. The thickness of the individual layers is measured on the clear edge on both samples using a microscope. The average of the two results is noted.

Calculation and expression of results





The analysed results are compared against a product declaration that is provided by the manufacturer. The following table is to be filled out (elements on the right represent an example):

Description	Ball
Name of licensee	
Model Name	
Ball Size and type (outdoor, futsal, beach soccer)	
Construction type (stitched, bonded, etc.)	
Number of panels in the construction	
Surface characteristics (structure)	
Casing Material (Carcass)	
Material Composition	
Thickness of surface layer (mm)	
Number of material layers in surface construction	
Bladder material	
Name of Valve & weight (g)	
Characterization of valve panel	

4 – Test requirements

The following tables indicate the requirements that must be met for a football to be eligible for certification.

4.1 Outdoor footballs

Tests	Outdoor				
	 Size 5	 Size 5	 Size 5	 Size 4	 Size 4
FIFA Football Test 01 1. Circumference [cm]	68.5 – 69.5	68.0 – 70.0	68.0 – 70.0	63.5 – 66.0	63.5 – 66.0
FIFA Football Test 02 2. Sphericity max. [%]	1.5	1.8	1.8	1.8	1.8
FIFA Football Test 03 3. Rebound height [cm] <ul style="list-style-type: none"> • At 20° C (room temp.) • At 5° C • Difference between highest and lowest rebound of the 3 tested balls 	135 – 155 min. 125 10	125 – 155 min. 115 10	125 – 155 min. 115 10	110 – 160 min. 110 10	110 – 160 min. 110 10
FIFA Football Test 04 4. Water absorption [%] (base: initial weight) <ul style="list-style-type: none"> • Max. absorption 	10	10	10	10	10
FIFA Football Test 05 5. Weight [g]	420 – 445	410 – 450	410 – 450	350 – 390	350 – 390
FIFA Football Test 06 6. Loss of pressure [%]	20	25	25	25	25
FIFA Football Test 07 7. Shape/size retention <ul style="list-style-type: none"> • Circumference (change) • Sphericity • Pressure (change) • Seams/valve 	max. 1.5cm max. 1.5% max. 0.1bar no damage	max. 1.5cm max. 1.8% max. 0.1bar no damage	–	–	–
FIFA Football Test 09 8. Material analysis	Complete information	Complete information	Complete information	Complete information	Complete information

4.2 Futsal

Tests	Futsal		
FIFA Football Test 01 1. Circumference [cm]	62.5 – 63.5	62.0 – 64.0	62.0 – 64.0
FIFA Football Test 02 2. Sphericity max. [%]	1.5	1.8	1.8
FIFA Football Test 03 3. Rebound height [cm] <ul style="list-style-type: none"> • At 20° C (room temp.) • At 5° C • Difference between highest and lowest rebound of the 3 tested balls 	55 – 65 – –	50 – 65 – –	50 – 65 – –
FIFA Football Test 05 4. Weight [g]	410 – 430	400 – 440	400 – 440
FIFA Football Test 06 5. Loss of pressure [%]	20	25	25
FIFA Football Test 07 6. Shape/size retention <ul style="list-style-type: none"> • Circumference (change) • Sphericity • Pressure (change) • Seams/valve 	max. 1.0cm max. 1.5% max. 0.1bar no damage	max. 1.0cm max. 1.8% max. 0.1bar no damage	–
FIFA Football Test 08 7. Balance → degree [°] <ul style="list-style-type: none"> • Average of 3 balls 	max. 5	max. 7.5	max. 7.5
FIFA Football Test 09 8. Material analysis	Complete information	Complete information	Complete information

4.3 Beach soccer

Tests	Beach Soccer		
FIFA Football Test 01 1. Circumference [cm]	68.0 – 70.0	68.0 – 70.0	68.0 – 70.0
FIFA Football Test 02 2. Sphericity max. [%]	1.8	1.8	1.8
FIFA Football Test 03 3. Rebound height [cm] <ul style="list-style-type: none"> • At 20° C (room temp.) • At 5° C • Difference between highest and lowest rebound of the 3 tested balls 	100 – 150 – –	100 – 150 – –	100 – 150 – –
FIFA Football Test 04 4. Water absorption [%] (base: initial weight) <ul style="list-style-type: none"> • Max. absorption 	10	10	10
FIFA Football Test 05 5. Weight [g]	420 – 440	400 – 440	400 – 440
FIFA Football Test 06 6. Loss of pressure [%]	20	25	25
FIFA Football Test 07 7. Shape/size retention <ul style="list-style-type: none"> • Circumference (change) • Sphericity • Pressure (change) • Seams/valve 	max. 1.5cm max. 1.8% max. 0.1bar no damage	max. 1.5cm max. 1.8% max. 0.1bar no damage	–
FIFA Football Test 09 8. Material analysis	Complete information	Complete information	Complete information